

# **PDP MODULE**

# **SERVICE MANUAL**

**MODEL : PDP42V6####**

## **CAUTION**

1. BEFORE SERVICING THE PDP MODULE,  
READ THE SAFETY PRECAUTIONS IN THIS MANUAL.
2. WHEN REPLACEMENT PARTS ARE REQUIRED, BE SURE TO USE  
REPLACEMENT PARTS SPECIFIED BY THE MANUFACTURER..

## SAFETY PRECAUTIONS

PDP Module is a display device to be divided into a Panel part and a Drive part. The Panel part consists of Electrodes, Phosphor, various dielectrics and gas, and the Drive part includes electronic circuitry and PCB. When using/handling this PDP Module, pay attention to the below warning and cautions.

### **Warning?**

Indicates a hazard that may lead to death or injury if the warning is ignored and the product is handled incorrectly.

### **Caution?**

Indicates a hazard that can lead to injury or damage to property if the caution is ignored and the product is handled incorrectly.

### **. WARNING**

- (1) Do not supply a voltage higher than that specified to this product. This may damage the product and may cause a fire.
- (2) Do not use this product in locations where the humidity is extremely high, where it may be splashed with water, or where flammable materials surround it. Do not install or use the product in a location that does not satisfy the specified environmental conditions. This may damage the product and may cause a fire.
- (3) If a foreign substance (such as water, metal, or liquid) gets inside the product, immediately turn off the power. Continuing to use the product, it may cause fire or electric shock.
- (4) If the product emits smoke, and abnormal smell, or makes an abnormal sound, immediately turn off the power. Continuing to use the product, it may cause fire or electric shock.
- (5) Do not disconnect or connect the connector while power to the product is on. It takes some time for the voltage to drop to a sufficiently low level after the power has been turned off. Confirm that the voltage has dropped to a safe level before disconnecting or connecting the connector.
- (6) Do not pull out or insert the power cable from/to an outlet with wet hands. It may cause electric shock.
- (7) Do not damage or modify the power cable. It may cause fire or electric shock.

- (8) If the power cable is damaged, or if the connector is loose, do not use the product: otherwise, this can lead to fire or electric shock.
- (9) If the power connector or the connector of the power cable becomes dirty or dusty, wipe it with a dry cloth. Otherwise, this can lead to fire.
- (10) PDP Module uses a high voltage (Max.450V dc). Keep the cautions concerning electric shock and do not touch the Device circuitry when handling the PDP Unit. And because the capacitor of the Device circuitry may remain charged at the moment of Power OFF, standing by for 1 minute is required in order to touch the Device circuitry.

### **. CAUTIONS**

- (1) Do not place this product in a location that is subject to heavy vibration, or on an unstable surface such as an inclined surface. The product may fall off or fall over, causing injuries.
- (2) Before disconnecting cable from the product, be sure to turn off the power. Be sure to hold the connector when disconnecting cables. Pulling a cable with excessive force may cause the core of the cable to be exposed or break the cable, and this can lead to fire or electric shock.
- (3) This product should be moved by two or more persons. If one person attempts to carry this product alone, he/she may be injured.
- (4) This product contains glass. The glass may break, causing injuries, if shock, vibration, heat, or distortion is applied to the product.
- (5) The temperature of the glass of the display may rise to 80°C or more depending on the conditions of use. If you touch the glass inadvertently, you may be burned.
- (6) If glass surface of the display breaks or is scratched, do not touch the broken pieces or the scratches with bare hands. You may be injured.
- (7) PDP Module requires to be handled with care not to be touched with metal or hard materials, and must not be stressed by heat or mechanical impact.
- (8) There are some exposed components on the rear panel of this product. Touching these components may cause an electric shock.
- (9) When moving the product, be sure to turn off the power and disconnect all the cables. While moving the product, watch your step. The product may be dropped or all, leading to injuries of electric shock.

- (10) In order to protect static electricity due to C-MOS circuitry of the Drive part, wear a wrist band to protect static electricity when handling.
- (11) If cleaning the Panel, wipe it with a soft cloth moistened with water or a neutral detergent and squeezed, being careful not to touch the connector part of the Panel. And don't use chemical materials like thinner or benzene.
- (12) If this product is used as a display board to display a static image, "image sticking" occurs. This means that the luminance of areas of the display that remain lit for a long time drops compared with luminance of areas that are lit for a shorter time, causing uneven luminance across the display. The degree to which this occurs is in proportion to the luminance at which the display is used. To prevent this phenomenon, therefore, avoid static images as much as possible and design your system so that it is used at a low luminance, by reducing signal level difference between bright area and less bright area through signal processing.
- (13) Because PDP Module emits heat from the Glass Panel part and the Drive circuitry, the environmental temperature must not be over 40°C.  
The temperature of the Glass Panel part is especially high owing to heat from internal Drive circuitry. And because the PDP Module is driven by high voltage, it must avoid conductive materials.
- (14) If inserting components or circuit board in order to repair, be sure to fix a lead line to the connector before soldering.
- (15) If inserting high-power resistor(metal-oxide film resistor or metal film resistor) in order to repair, insert it as 10mm away as from a board.
- (16) During repairs, high voltage or high temperature components must be put away from a lead line.
- (17) This is a Cold Chassis but you had better use a cold transformer for safety during repairs. If repairing electricity source part, you must use the cold transformer.
- (18) Do not place an object on the glass surface of the display. The glass may break or be scratched.
- (19) This product may be damaged if it is subject to excessive stresses (such as excessive voltage, current, or temperature). The absolute maximum ratings specify the limits of these stresses.
- (20) The recommended operating conditions are conditions in which the normal operation of this product is guaranteed. All the rated values of the electrical specifications are guaranteed within these conditions.  
Always use the product within the range of the recommended operating conditions. Otherwise, the reliability of the product may be degraded.
- (21) This product has a glass display surface. Design your system so that excessive shock and load are not applied to the glass. Exercise care that the vent at the corner of the glass panel is not damaged.  
If the glass panel or vent is damaged, the product is inoperable.
- (22) Do not cover or wrap the product with a cloth or other covering while power is supplied to the product.
- (23) Before turning on power to the product, check the wiring of the product and confirm that the supply voltage is within the rated voltage range. If the wiring is wrong or if a voltage outside the rated range is applied, the product may malfunction or be damaged.
- (24) Do not store this product in a location where temperature and humidity are high. This may cause the product to malfunction. Because this product uses a discharge phenomenon, it may take time to light (operation may be delayed) when the product is used after it has been stored for a long time. In this case, it is recommended to light all cells for about 2 hours (aging).
- (25) This product is made from various materials such as glass, metal, and plastic. When discarding it, be sure to contact a professional waste disposal operator.
- (26) If faults occur due to arbitrary modification or disassembly, LG Electronics is not responsible for function, quality or other items.
- (27) Use of the product with a combination of parameters, conditions, or logic not specified in the specifications of this product is not guaranteed. If intending to use the product in such a way, be sure to consult LGE in advance.
- (28) Within the warranty period, general faults that occur due to defects in components such as ICs will be rectified by LGE without charge. However, IMAGE STICKING due to misapplying the above (12) provision is not included in the warranty. Repairs due to the other faults may be charged for depending on responsibility for the faults.

# [PDP42V6#### Module]

## CONTENTS

### ⅃ . Formation and Specification of Module

### ⅃-. Adjustment

### ⅃†. Trouble Shooting

#### 1. Checking for No Picture

#### 2. Hitch Diagnosis Following Display Condition

2-1. 4/7 or 3/7 of the screen doesn't be shown

2-2. Screen doesn't be shown as Data COF

2-3. It is generated unusual pattern of Data COF IC unit

2-4. Regular Stripe is generated about the quantity of one Data COF IC or more

2-5. Screen doesn't be shown at all as scan COF

2-6. Regular stripe is generated at regular interval on the whole screen

2-7. Data copy is generated to stripe direction

2-8. One or more stripe is generated on the screen

2-9. One or more horizontal line is generated on screen

2-10. Lightness of screen is wholly darkened though there is input-signal-pattern

2-11. Different color is shown partially during full-white-screen or electric discharge is generated during full-black-screen

2-12. Full-white pattern it happened that the lightness of middle is darkened while full-white pattern

2-13. Some lightness of some color doesn't not generated well

#### 3. Checking for component damage

3-1. Y IPM(IC 12) or Z IPM(IC 4) damage

3-2. FET Ass'y(Y B/D: HS1) damage

3-3. SCAN IC(Y drv B/D: IC1~8) damage

3-4. COF damage

3-5. Crystal(CTRL B/D: X1) damage

### ⅃‡. Block Diagram

### ⅃-. Records of Revision for Boards, components and ROM DATA

### \* Annexing : Schematic Diagram

## ㉞ . Formation and Specification of Module

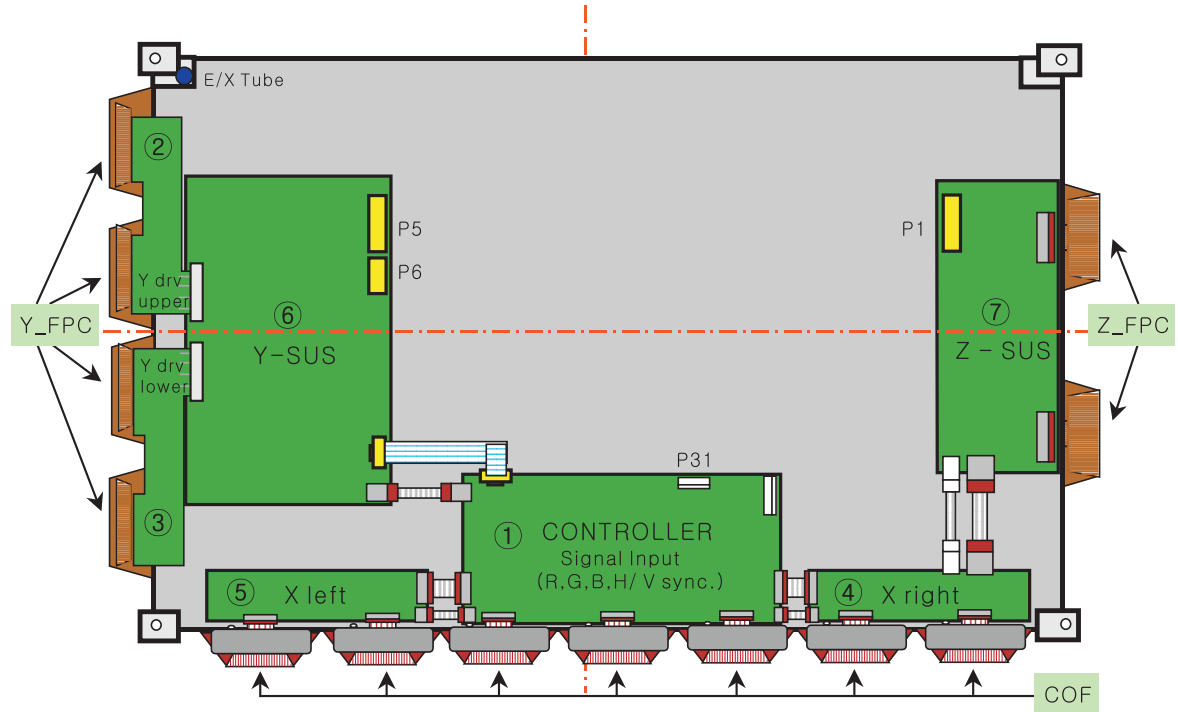

### External Cable Connection

NO	Connector	Input Voltage & Signal
1	P1[Z SUS B/D]	5V, Va, Vs
2	P5[Y SUS B/D]	Vs
3	P6[Y SUS B/D]	5V
4	P31[CTRL B/D]	Video Signal

NO	Part No.		Description
①	6871QCH034A	PWB(PCB) ASSY	LVDS CTRL B/D ASSY
②	6871QDH066A	PWB(PCB) ASSY	Y DRV UPPER B/D ASSY
③	6871QDH067A	PWB(PCB) ASSY	Y DRV LOWER B/D ASSY
④	6871QRH037A	PWB(PCB) ASSY	X RIGHT B/D ASSY
⑤	6871QLH034A	PWB(PCB) ASSY	X LEFT B/D ASSY
⑥	6871QYH029A	PWB(PCB) ASSY	Y SUS B/D ASSY
⑦	6871QZH033A	PWB(PCB) ASSY	Z SUS B/D ASSY

## ⅴ-. Adjustment

### 1. Application Object

This standard is applied to the PDP42V6#### PDP Module which is manufactured by the manufacturing team of PDP promotion department or elsewhere.

### 2. Notes

- (1) Without any special specification, the Module should be at the condition of preliminaries more than 10minutes before adjusting.
  - Service signal : 100% Full White signal
  - Service DC voltage : Vcc: 5V, Va: 65V, Vs: 185V
  - DC/DC Pack voltage : Vsetup: 200V, Vscw: 115V, -Vy: -75V
  - Preliminaries environment : Temp (25±5°C), Relative humidity (65±10%)
- (2) Module should get the Aging for the equilibrium after finish the assembling. Aging condition is shown below.
  - Service signal: 100% Full White, Red, Green, Blue pattern signal(Service time of each pattern : within 5minutes/cycle)
  - Service DC voltage : Match the voltage with the set up voltage in the first adjustment.
  - Aging time : More than 4Hrs
  - Aging environment : Temp (60±2°C), Relative humidity-Less than 75%
- (3) Module adjustment should be followed by below sequence.
  - Setting up the initial voltage and adjusting the voltage wave form of Vsetup
  - Measuring the Margin of Vs voltage and deciding the voltage
  - Adjusting and checking the voltage of DC/DC pack (Vsetup, Vscw, -Vy)
  - Adjusting the voltage wave form of Vset-down
  - Measuring the Margin of Vset-up voltage and deciding the voltage
  - Adjusting the wave form of final voltageBut, these items above can be changed by the consideration of mass production. (When changing the sequence, there should be an agreement of the Module development 2Gr./ QA Gr./ Manufacturing Gr.)
- (4) Without any special specification, you should adjust the Module in the environment of Temp (25±5°C) and Relative humidity (65±10%)

**Caution** If you let the still image more than 10 minutes(especially The Digital pattern or Cross Hatch Pattern which has clear gradation), after image can be presented in the black level part of screen.

### 3. Adjustment items

#### 3-1. Adjusting the Board Group

- (1) Adjusting the voltage wave form of Vset-up
- (2) Adjusting the voltage wave form of Vset-down
- (3) Adjusting the voltage wave form of Vramp

#### 3-2 Adjustment after assembling

##### (PDP Module adjustment)

- (1) Setting up the initial voltage and adjusting the voltage wave form of Vsetup
- (2) Measuring the voltage Margin of Vs and deciding the voltage
- (3) Adjusting and checking the voltage of DC/DC pack (Vsetup, Vscw, -Vy)
- (4) Adjusting the voltage wave form of Vset-down
- (5) Measuring the Margin of Vset-up voltage and deciding the voltage
- (6) Adjusting the wave form of final voltage

### 4. Adjusting the Board Group

#### (Applying the Jig Set)

#### 4-1. Using Tools

- (1) Digital oscilloscope : More than 200MHz
- (2) DVM(Digital Multimeter) : Fluke 87 or similar one
- (3) Signal generator : VG-825 or similar one
- (4) DC power supply
  - DC power supply for Vs (1) : Should be changeable more than 0-200V/ more than 10A
  - DC power supply for Va (1) : Should be changeable more than 0-100V/ more than 5A
  - DC power supply for 5V (1) :Should be changeable more than 0-10V/ more than 10A
  - DC-DC Converter Jig (1) : The Jig which has voltage equivalent output of PDP42V6#### Module after taking the Vs, Va, 5V voltage
  - Voltage stability of power supply : Within ±1% for Vs/Va, within ±3% for 5V

#### 4-2. Connection diagram of measuring instrument and setting up the initial voltage

- (1) Connection diagram of measuring instrument  
Refer to Fig. 1.(Connection diagram of measuring instrument that adjusting the voltage wave form)
- (2) Setting up the initial voltage  
Initially setting up voltage : Vcc: 5V, Va: 65V, Vs: 185V  
But, Initially setting up voltage can be changed by the set up range according to the Module's characteristic.

#### 4-3. How to Adjust

- (1) Adjusting the Voltage Wave form of Vsetup
  - Connect measuring instrument like the connection diagram Fig. 1.
  - Turn on the power of the measuring instrument like the <Caution> item Fig. 1.
  - Connect the oscilloscope probe to P4 connector(80 Pin) of Y-SUS PCB and GND.
  - Turn the VR1 of Y-SUS PCB and make the "A" wave form Fig. 2 to be 20±1μs.

- (2) Adjusting Vset-down Voltage Wave form  
Turn the VR2 of Y-SUS PCB and make the "B" wave form Fig. 2 to be  $150\pm 5\mu s$ .

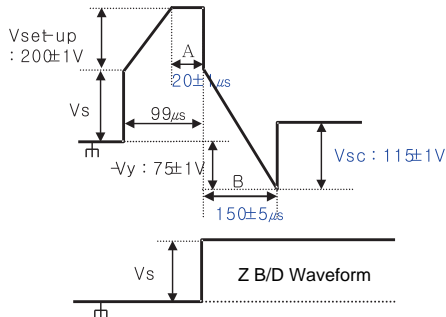

(Fig. 2) Y, Z set-up Waveform

- (3) Adjusting the Voltage Wave form of Vramp  
 Connect oscilloscope Probe to the B37 Pin on Z PCB and the GND.  
 Turn the VR3 of Z PCB and make the "C" wave form Fig. 3 to be  $7\mu s$ .

But, in case of not setting up the Test point, produce same output and adjust wave form connect to other pattern or parts which has no possibility of short.

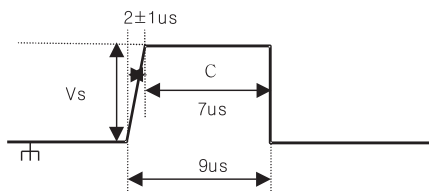

(Fig. 3) Z ramp Waveform

## 5. Adjustment after Assembling (PDP Module Adjustment)

### 5-1. Using Tools

- (1) Digital oscilloscope : More than 200MHz
- (2) DVM(Digital Multimeter): Fluke 87 or similar one
- (3) Signal generator: VG-825 or similar one
- (4) DC power supply
  - DC power supply for Vs (1) : Should be changeable more than 0-200V/ more than 10A
  - DC power supply for Va (1) : Should be changeable more than 0-100V/ more than 5A
  - DC power supply for 5V (1) : Should be changeable more than 0-10V/ more than 10A
  - DC-DC Converter Jig (1) : The Jig which has voltage equivalent output of PDP42V6#### Module after taking the Vs, Va, 5V voltage
  - Voltage stability of power supply : Within  $\pm 1\%$  for Vs/Va, within  $\pm 3\%$  for 5V

### 5-2. Connection diagram of measuring instrument and setting up the initial voltage

- (1) Connection diagram of measuring instrument  
Refer to figure 1. (Connection diagram of measuring instrument that adjusting the voltage wave form)
- (2) Setting up the initial voltage  
Initially setting up voltage : Vcc: 5V, Va: 65V, Vs: 185V

But, Initially setting up voltage can be changed by the set up range according to the Module's characteristic.

### 5-3. How to Adjust

#### (1) Adjusting initial voltage wave form

Check the voltage wave form like the mentioned way on the 4-3(How to adjust) and readjust the wave form when it is wrong.

#### (2) Checking the DC/DC pack voltage

- Convert the signal of signal generator to the 100% Full White signal
- Connect the GND terminal of DVM to the R30's right leg of the Y B/D and set the Plus terminal to the left leg of R30 to check the Vscw voltage( $115\pm 1V$ ) and when there is abnormality in voltage turn the variable resistor(VR5) of DC/DC Pack(Vscw) on Y B/D to adjust.
- Connect the GND terminal of DVM to the R31's right leg of the Y B/D and set the Plus terminal to the left leg of R31 to check the -Vy voltage( $-75\pm 1V$ ) and when there is abnormality in voltage turn the variable resistor(VR6) of DC/DC Pack(-Vy) on Y B/D to adjust.
- Connect the GND terminal of DVM to the R27's right leg of the Y B/D and set the Plus terminal to the left leg of R27 to check the Vsetup voltage( $200\pm 1V$ ) and when there is abnormality in voltage turn the variable resistor(VR4) of DC/DC Pack(Vsetup) on Y B/D to adjust.

### **(3) Measuring the Vs voltage Margin and deciding the voltage**

- Convert the signal of signal generator to the 100% Full Red signal.
- Turn the voltage adjusting knob of Vs DC power supply to the voltage -down direction and make the cell of screen turned off.
- Turn the voltage adjusting knob of Vs DC power supply to the voltage -up direction until the cell of screen turned on. The first voltage, which make the cell of full screen turned on, is named as Vsmin1 and record it.
- Turn the voltage adjusting knob of Vs DC power supply to the voltage-up direction slowly until the cell of screen turned off or over electric discharge. The first voltage, which makes the cell of screen turned off or over electric discharge, is named as Vsmax1 and records it. (Only, Vs voltage variable passes over the maximum 190V)
- Convert the signal of signal generator to the 100% Full Green signal.
- Repeat the adjustment (2) item and name each voltage as Vsmin2/Vsmax2 and record them.
- Convert the signal of signal generator to 100% Full Blue signal.
- Repeat the adjustment (2) item and name each voltage as Vsmin3/Vsmax3 and record them.
- Convert the signal of signal generator to 100% Full White signal.
- Repeat the adjustment (2) item and name each voltage as Vsmin4/Vsmax4 and record them.
- Convert the signal of signal generator to 100% Full Black signal.
- Repeat the adjustment (2) item and name each voltage as Vsmin5/Vsmax5 and record them.
- At this time decided Vs voltage adds 6V to Max value(Vsmin1~Vsmin5) and set up the voltage within the set-up range( $180V < Vs \leq 190V$ ) in consideration of other features.
- Turn the voltage adjusting knob of Vs DC power supply make deciding the Vs voltage.
- Adjust Vset-down wave form using setting up Vs voltage like mentioned on the 4-3.

### **(4) Adjusting the final voltage wave form**

Check the voltage wave form like the mentioned way on the 4-3(How to adjust) and readjust the wave form when it is twisted.

### **(5) DC-DC Pack Voltage Set up Range**

Vsetup : 185V ~ 225V

Vsc : 90V ~ 120V

-Vy : -60V ~ -80V



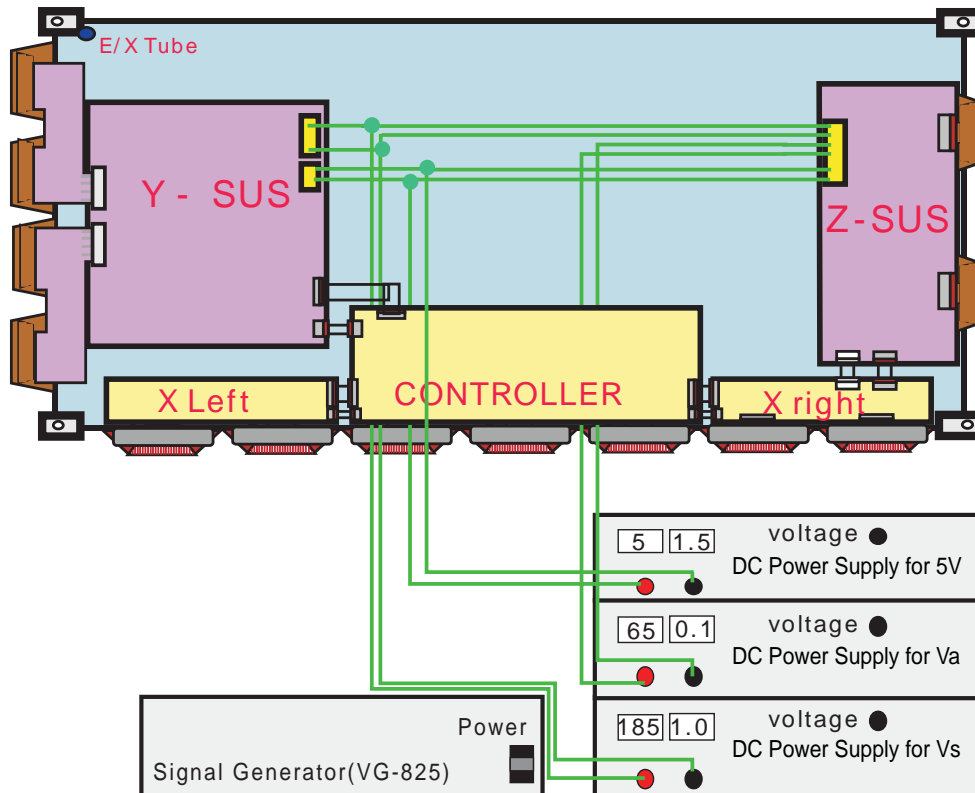

- <Caution>**
- (1) The power of the signal generator should be turned on before turning on the power of DC power supply.
  - (2) The voltage of DC power supply , in standard of Module input voltage, should be preset as below.  
Vcc: 5V, Va: 65V, Vs: 185V
  - (3) The power of power supply must turned on by this sequence. Reverse direction When turning off.  
\* Module on : 5V ⇒ Va ⇒ Vs, Module off: Vs ⇒ Va ⇒ 5V
  - (4) Signal generator should be selected with 852\*480(WVGA) mode

(Fig. 1) Connection diagram of measuring instrument

## Ⅳ. Trouble Shooting

### 1. Checking for no Picture

A screen doesn't display at all and condition of black pattern or power off.

- (1) Check whether the CTRL B/D LED(D10, D11, D12, D13, D17) is turned on or not.
- (2) Check the power and signal cable of CTRL B/D.
- (3) X B/D, Y B/D, Z B/D is well plugged in.
- (4) Check the connection of X B/D, Y B/D and Z B/D to CTRL B/D.
- (5) Measure the output wave of X, Y, Z B/D with oscilloscope(more than 200MHz) and find the trouble of B/D by comparing the output wave with below figure.
  - Measure Point fo Y B/D : TP(Bead B103)
  - Measure Point fo Z B/D : TP(Bead B37)
  - Measure Point fo X B/D : COF TP
- (6) Check the SCAN(Y side) IC
- (7) Check the DATA(X side) COF IC
- (8) Replace the CTRL B/D.

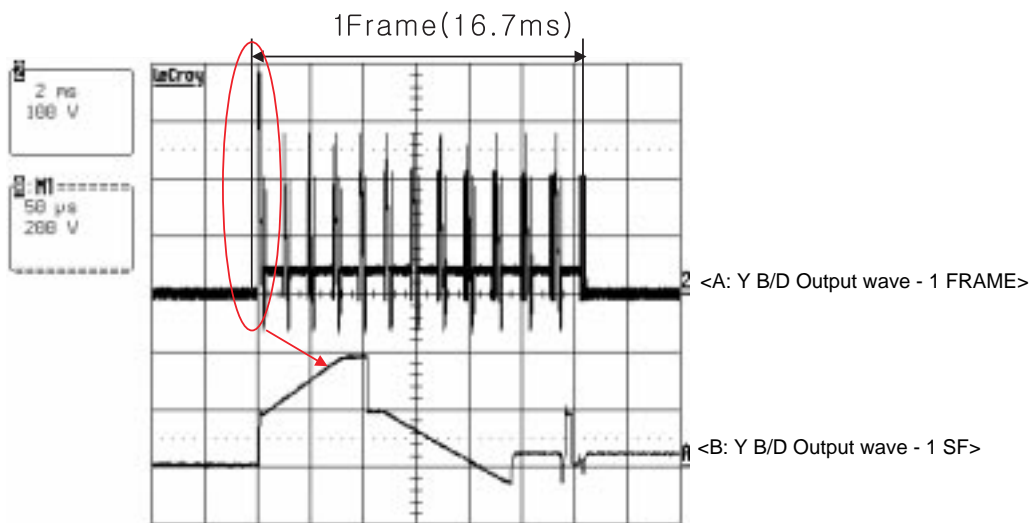

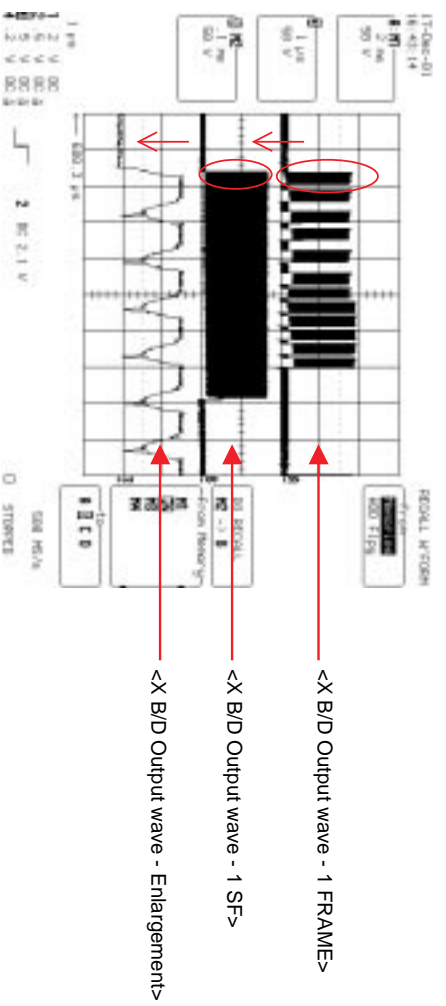
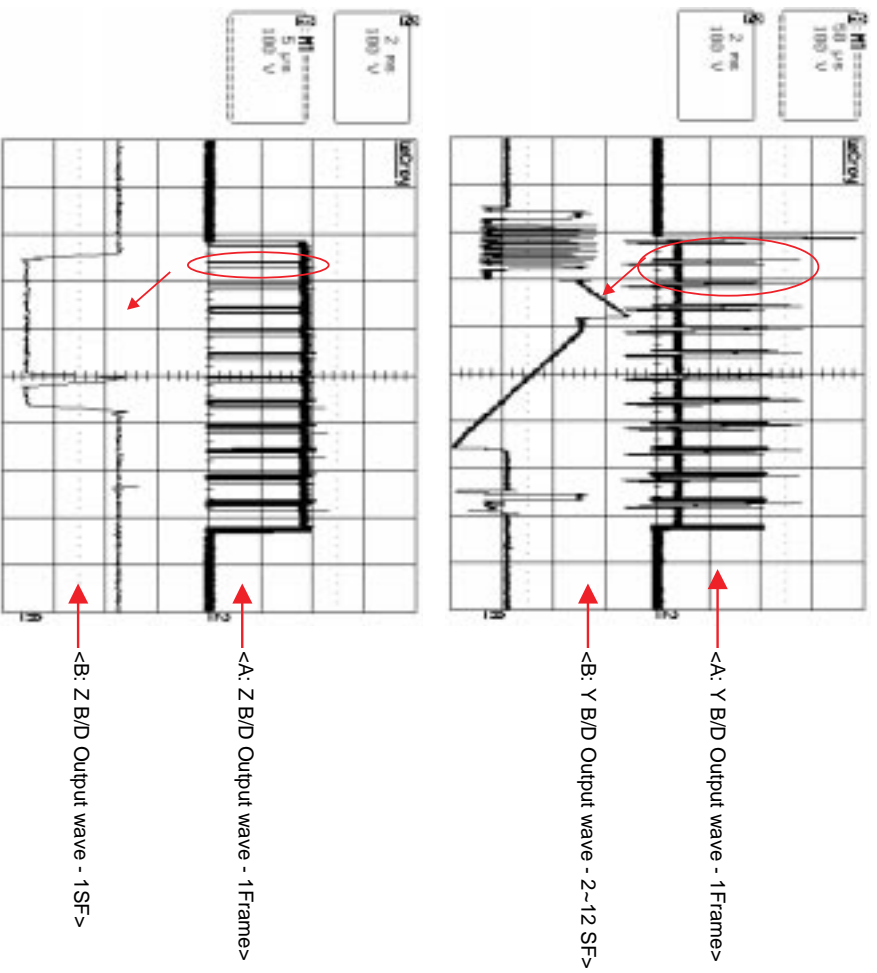

## 2. Hitch Diagnosis Following Display Condition

### 2-1. 4/7 or 3/7 of the screen doesn't be shown

- (1) Confirm the power connector of X B/D is well plugged in which is correspond to not showing screen.
- (2) Confirm the connector that is connected between CTRL B/D and X B/D correspond to not showing part.
- (3) Replace relevant X B/D.

#### \* Relationship between screen and X B/D

Screen		X B/D
Left of the Screen 4/7	<-->	Right X B/D
Right of the Screen 3/7	<-->	Left X B/D

#### \* Screen Display Form

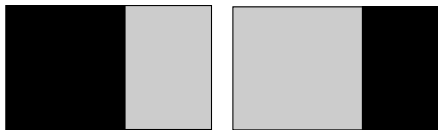

Left of the Screen(4/7)      Right of the Screen(3/7)

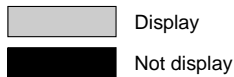

### 2-2. The screen doesn't be shown as Data COF

(Include not be shown part of Data COF quantity or a part)

- (1) The problem between Data COF and X B/D is more possible that the screen is not be shown as data COF.
- (2) Confirm the connector of Data COF is well connected to X B/D. Correspond to the part that screen is not showing
- (3) Confirm whether the Data COF is failed and replace X B/D

#### \* Example of the screen display form

(Anything of the 7 Data COF can be shown beside below pictures)

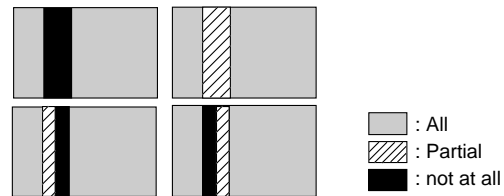

#### \* How to examine Data COF IC

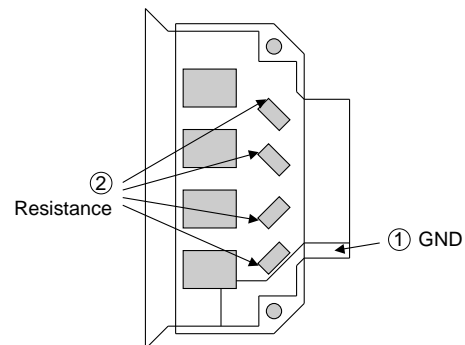

- Change ' ① GND' into ANODE, ' ② Resistance' into CATHOD and then examine the Diode to the forward or reverse direction.
- Measure the resistance value(10Ω)

### 2-3. It Generates Unusual Pattern of Data COF IC unit

- (1) In case of generating unusual pattern of Data COF IC unit as below picture, there is problem in the check that is input into Data COF IC
- (2) In case of <case 1, 2, 3>
  - confirm the connection of Data COF connector
  - replace the relevant X B/D
- (3) In case of <case 4, 5>
  - confirm the connector that is connected from CTRL to X B/D
  - Replace relevant XB/D or CTRL B/D

### 2-4. Regular Stripe is Generated about the Quantity of one Data COF IC or more

- (1) In case of generating regular stripe about the quantity of one Data COF IC, there is problem at the output of output-flatworm of X B/D  
 In case of generating regular stripe about the quantity of two Data COF IC, that means the data which is conveyed from CTRL B/D doesn't conveyed well.
- (2) Confirm the XB/D connection connector plugged in well. Correspond to unusual screen.
- (3) Replace relevant XB/D or CTRL B/D.

#### \* Screen Display Form

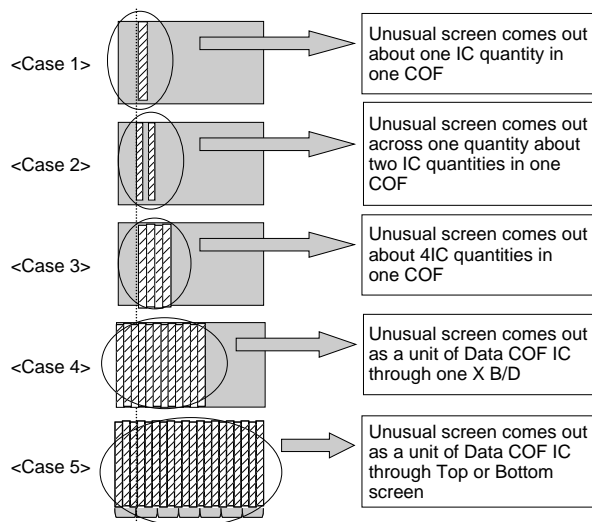

#### \* Relationship between screen and X B/D

Screen		X B/D
Left of the Screen	4/7 <-->	Right X B/D
Right of the Screen	3/7 <-->	Left X B/D

#### \* Screen Display Form

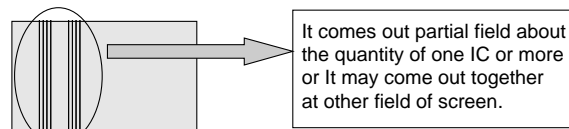

**2-5. The screen display has a problem for Scan FPC.**

- (1) It's may be a problem between Scan FPC and Y B/D.
- (2) Check the connection of Y B/D and Scan FPC.
- (3) If the Scan IC is failed, replace the Y DRV B/D.

**\* Screen Display Form**

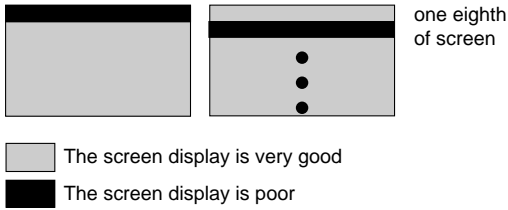

**\* Check a method of SCAN IC**



Change the Vpp Pin into ANODE and GND Pin into CATHOD and then test the Diode with forward or reverse direction.

**2-6. The screen has a vertical line with regular gap.  
(A vertical stripe flash at especial color)**

- (1) This is a problem about control B/D.
- (2) Replace Control B/D.

**\* Screen Display Form**

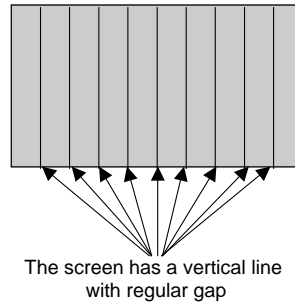

**2-7. A data copy is happened into vertical direction**

- (1) In this case, it's due to incorrect marking of scan wave.
- (2) Replace a Y DRV B/D or Y SUS B/D.

**\* Screen Display Form**

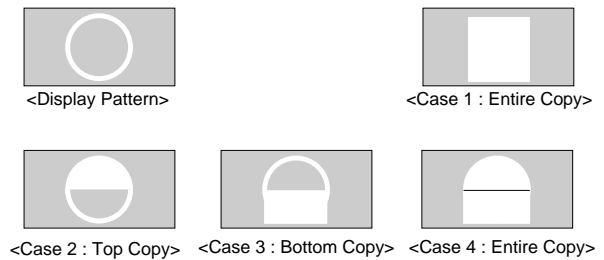

**2-8. The screen has one or several vertical line**

- (1) In this case, It isn't a problem about controller B/D or X B/D.
- (2) It may cause followings.
  - It's out of order a panel
  - Open or short of DATA COF FPC attached panel
  - It's out of order a DATA COF attached panel
- (3) Replace Module.

**\* Screen Display Form**

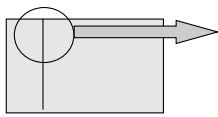

It may show several vertical lines in a quarter or other division part of screen including left case.

**2- 9. The screen has one or several horizontal line**

- (1) In this case, it isn't a problem about controller B/D or X B/D.
- (2) It may cause followings.
  - It's out of order a panel
  - Open or short of SCAN FPC attached panel
  - It's out of order a SCAN IC attached panel
- (3) Replace Y DRV B/D

**\* Screen Display Form**

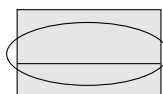

It may show several horizontal lines including left case.

**2-10. The screen displays input signal pattern but the brightness is dark**

- (1) In this case, Z B/D operation isn't complete.
- (2) Check the power cord of Z B/D.
- (3) Check the connector of Z B/D and Controller B/D.
- (4) Replace the Controller B/D or Z B/D.

**2-11. The screen displays other color partially on full white screen or happens discharge partially on full black screen.**

- (1) Check the declination of Y B/D set up, set down wave.
- (2) Check the declination of Z B/D ramp wave.
- (3) Measure each output wave with oscilloscope(more than 200MHz) and compare the data with below figure data. Adjust the Y B/D set up(Test-up:B/C[ $\mu$ s/ $\mu$ s])/setdown(Test-down:D[ $\mu$ s]) and Z B/D ramp(Tramp:F/G[ $\mu$ s/ $\mu$ s]) declination by changing VR1/VR2/VR3.
  - Measuring Point of Y B/D : B103(SUS\_UP)
  - Measuring Point of Z B/D : B37(SUS\_OUT)

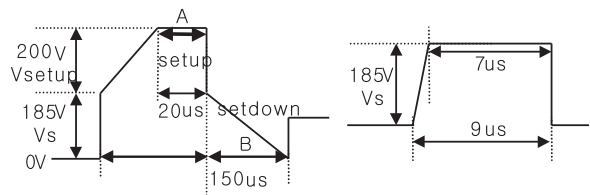

Y Output Voltage Wave form

Z RAMP Voltage Wave form

**2-12. A center of screen is darker than a edge of screen at full white pattern.**

- (1) In this case, it's a problem about Z B/D ramp wave.
- (2) Check the connection cable of Z B/D and CTRL B/D.
- (3) Replace the Z B/D.

**\* Screen Display Form**



**2-13. It doesn't display a specified brightness at specified color**

- (1) Check the connector of CTRL B/D input signal.
- (2) Replace the CTRL B/D.



### 3. Checking for component damage

#### 3-1. Y IPM(IC 12) or Z IPM(IC 4) damage

- (1) When the internal Sustain\_FET of Y IPM(IC 12) or Z IPM(IC 4) is damaged, screen doesn't be shown or electric discharge is generated.
  - Test Point: GND~B103(Y B/D), GND~B37(Z B/D)
  - Wave format: B103(Y B/D) or B37(Z B/D) has no wave output
- (2) When the internal ER\_FET of Y IPM(IC 12) or Z IPM(IC 4) is damaged, Y IPM or Z IPM emission is increased.
  - Test Point: GND~B103(Y B/D), GND~B37(Z B/D)
  - Wave format: As shown (Fig. 1)

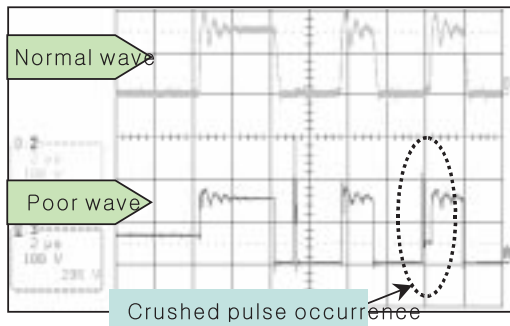

(Fig. 1) When the ER\_FET is damaged

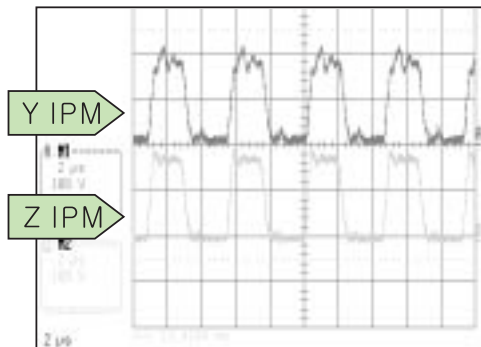

<IPM Normal Output Wave >

- Measrance position: Sustain section enlarge the after measuring B103 wave of Y B/D and B37 wave of Z B/D. (Full White Pattern)

#### 3-2. FET Ass'y(Y B/D: HS1) damage

- (1) When Set\_Up FET is damaged, screen doesn't be shown
  - Test Point: Enlarge the after measuring GND~B103(Y B/D)
  - Wave format: As shown (Fig. 2)

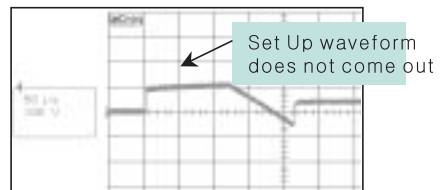

(Fig. 2) When the Set\_Up FET is damaged

- (2) When Set\_Down FET is damaged, electric discharge of entire screen is generated.
  - Test Point: Enlarge the after measuring GND~B103(Y B/D)
  - Wave format: As shown (Fig. 3)

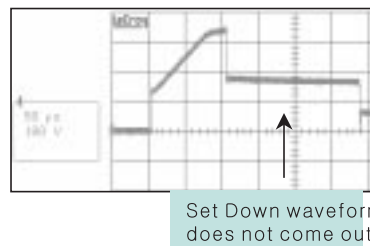

(Fig. 3) When the Set\_Down FET is damaged

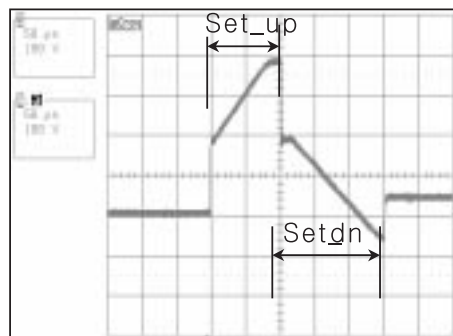

<FET Ass'y Normal Output Wave >

- Measrance position: Reset section enlargement wave of TP B103(Y B/D) (Full White Pattern)

### 3-3. SCAN IC(Y drv B/D: IC1~8) damage

(1) In case of SCAN IC poor, one horizontal line may open at screen.

- Test Point: ICT measurement of GND~Y drive B/D output
- Wave format: As shown (Fig. 4)

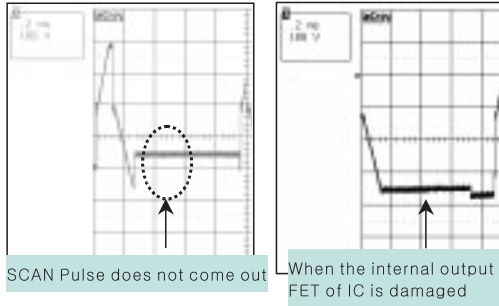

(Fig. 4) When SCAN IC is poor

(2) Screen may not shown when SCAN IC is damaged by SCAN IC poor, external electricity or spark.

- Test Point: ICT measurement of GND~Y drive B/D output
- Wave format: Output wave format isn't output (You can see the damage for Y drive B/D Top or Bottom's SCAN IC)

(3) Screen shaken horizontally when Y drv B/D Top and Bottom cable is poor

- Test Point: ICT measurement of GND~Y drive B/D output
- Wave format: As shown (Fig. 5)

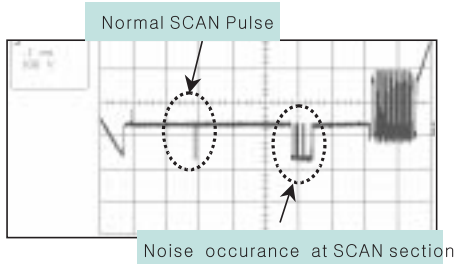

(Fig. 5) When Y drv B/D Top and Bottom cable is poor

(4) In case of shorting the SCAN IC output by a dust, foreign substance, it may overlap two horizontal lines on screen.

- Test Point: ICT measurement of GND~Y drive B/D output
- Wave format: As shown (Fig. 6)

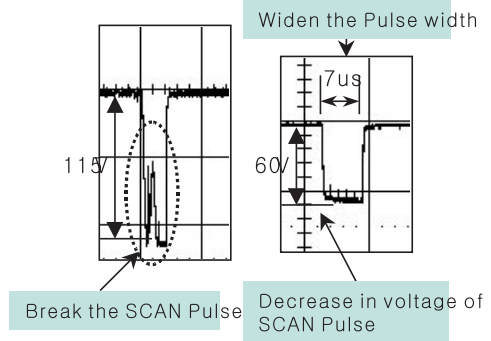

(Fig. 6) When SCAN IC output is short

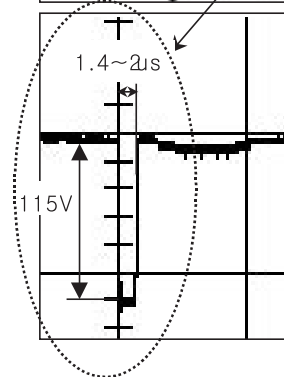
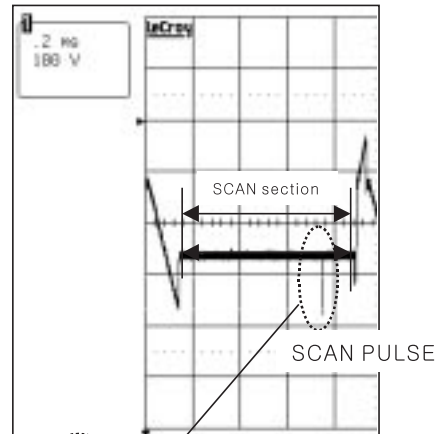

<SCAN IC Normal Output Wave >

- Measurement position: SCAN section enlarge the after measuring output ICT of Y drive B/D. (Full White Pattern)

### 3-4. COF damage

- (1) In case of shorting or opening the IC output of COF, it may show one or several vertical lines.
- Test Point: Enlarge the after measuring output TP of GND-COF
  - Wave format: As shown Output of (Fig. 7)
- In case of normal wave output, when STB signal is generated, maintain High output. And when STB signal is generated again must be fall Low. But when IC of COF is poor, STB signal is not generated Output falls with Low.

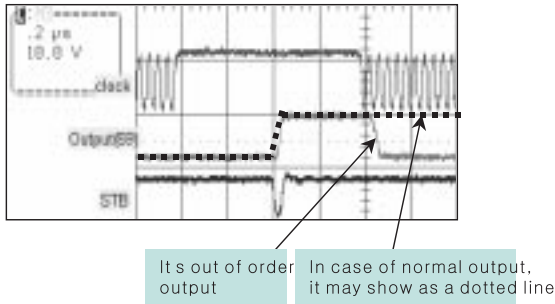

(Fig. 7) When IC output of COF is poor

- (2) In case of being damage IC of COF or power resistance, the screen doesn't be shown or happens discharge partially.
- Test Point: Enlarge the after measuring output TP of GND-COF
  - Wave format: Output wave doesn't come out

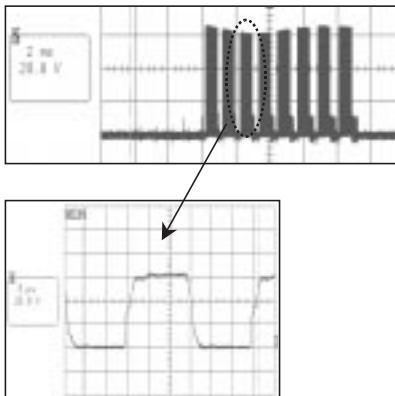

<COF Normal Output Wave >

- Measurement position: Enlarge the after measuring output TP of COF (Full White Pattern)

### 3-5. Crystal(CTRL B/D: X1) damage

- (1) When Crystal is damage, the screen doesn't be shown.
- Test Point: Measuring 3pin of GND-Crystal(Ctrl B/D: X1)
  - Wave format: Output wave doesn't come out
- (2) In case of unusual launch of the Crystal, it may blink the screen.
- Wave format: As shown (Fig. 8)

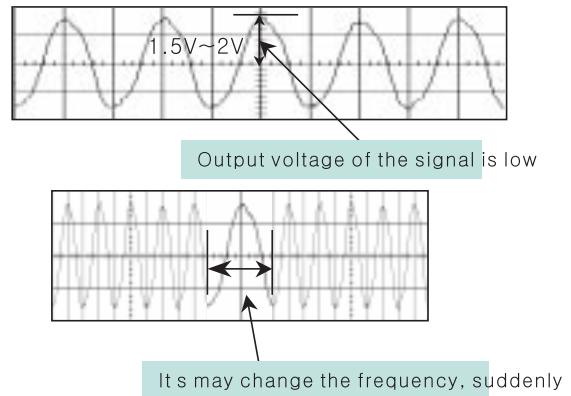

(Fig. 8) When Crystal is poor

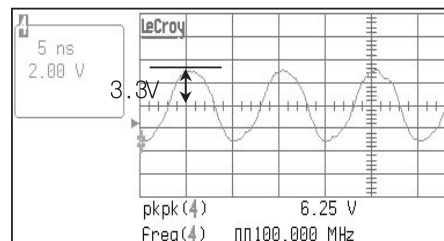

<Crystal Normal Output Wave >

- Measurement position: Measuring output 3pin of Crystal(X1: 100MHz) on Ctrl B/D (Full White Pattern)

## ⚠ Block Diagram

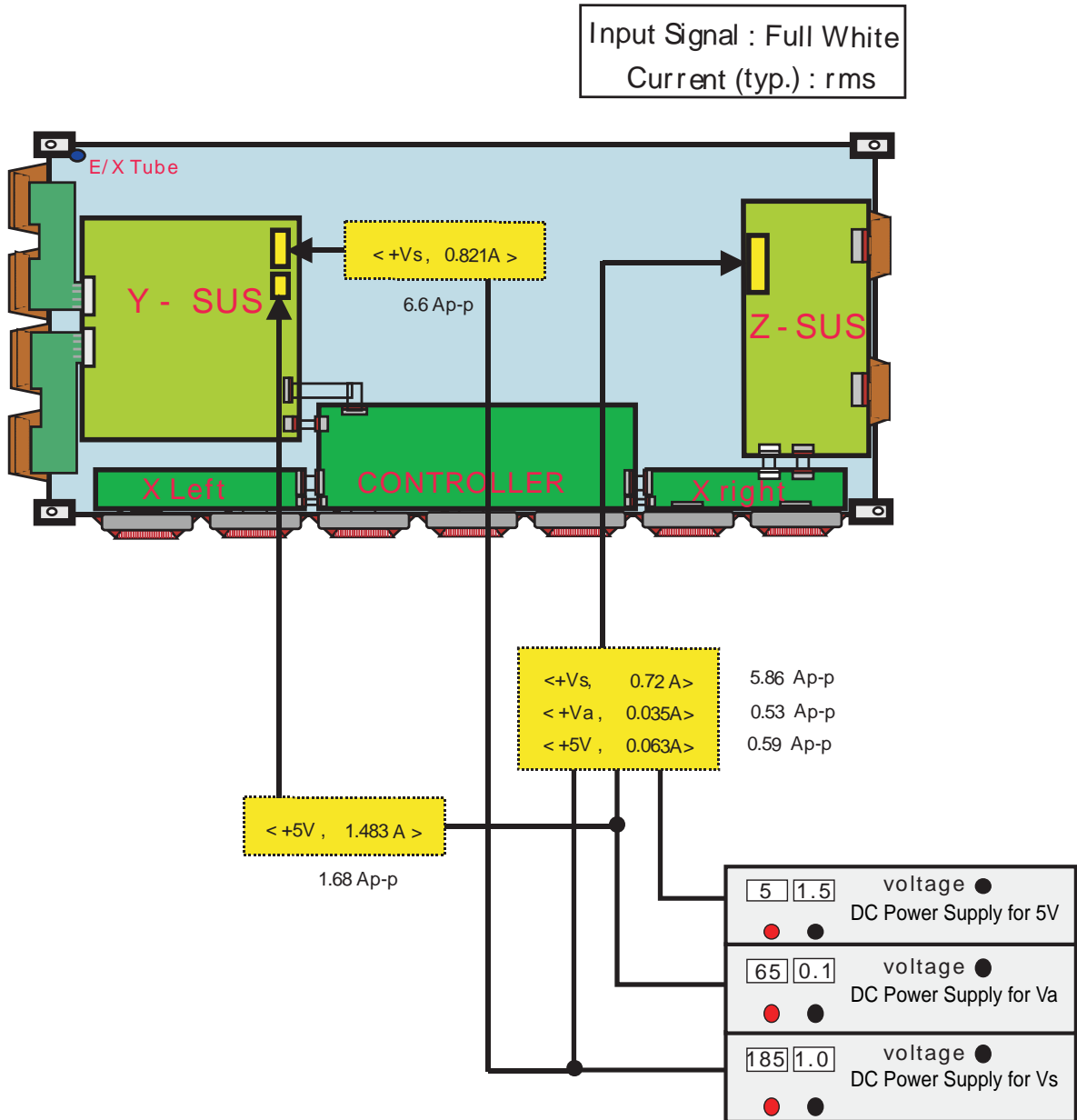

## Ⅴ. Records of Revision for Boards, components and ROM DATA

### 1. Boards

No.	Date	Board	Part Number	Note
1	2004.01.21	CTRL B/D ASSY(LVDS)	6871QCH034A	Initial Product
2	2004.01.21	YDRV Upper B/D ASSY	6871QDH066A	Initial Product
3	2004.01.21	YDRV Lower B/D ASSY	6871QDH067A	Initial Product
4	2004.01.21	Y SUS B/D ASSY	6871QYH029A	Initial Product
5	2004.01.21	Z SUS B/D ASSY	6871QZH033A	Initial Product
6	2004.01.21	X RIGHT B/D ASSY	6871QRH037A	Initial Product
7	2004.01.21	X LEFT B/D ASSY	6871QLH034A	Initial Product
8	2004.02.23	CTRL B/D ASSY(LVDS)	6871QCH034A	COF Resistor added
9	2004.02.23	Y SUS B/D ASSY	6871QYH029A	R90, R91, C33, P5, P6 changed
10	2004.02.23	Z SUS B/D ASSY	6871QZH033A	C7 added
11	2004.02.23	X RIGHT B/D ASSY	6871QRH037A	4 layers changed
12	2004.02.23	X LEFT B/D ASSY	6871QLH034A	4 layers changed

## 2. COMPONENTS

No.	Date	COMPONENT	Part Number	Remark
1	2004.01.21	Y IPM(Y B/D: IC 12)	4921QP1023A	Initial Product Apply to DRIVER IC: IR2113S
2	2004.01.21	Z IPM(Z B/D: IC 4)	4921QP1024A	Initial Product Apply to DRIVER IC: IR2113S
3	2004.01.21	FET(Y B/D: HS1)	4921QF2004A	Initial Product Set_up/Set-dn FET Ass'y
4	2004.01.21	COF	0ILNRAZ015D	Initial Product Check the inner resistance in 0 Ohm
5	2004.01.21	Crystal(CTRL B/D: X1)	6212AB4004A	Initial Product
6	2004.01.21	SCAN IC(Y drive B/D: IC1~8)	0ILNRMA011A	Initial Product Matsushida: AN16001A
7	2004.03.01	COF	0ILNRHS001A	Check the inner resistance in 10 Ohm
8	2004.04.05	SCAN IC(Y drive B/D: IC1~8)	0ILNRTI020A	TI: SN755866
9	2004.04.05	Y IPM(Y B/D: IC 12)	4921QP1025A	Apply to DRIVER IC: IXYS
10	2004.04.05	Z IPM(Z B/D: IC 4)	4921QP1026A	Apply to DRIVER IC: IXYS



## SPARE PART LIST

### V6 (LG)

Parts Code	Description
X56101	PCB ASSY LVDS LV42V6 (6871QCH034A)
X56103	PCB ASSY Y-DRIVE UP LG42V6 (6871QDH066A)
X56104	PCB ASSY Y-DRIVE(UST) LG42V6 (6871QDH067A)
X56105	PCB ASSY X-DRIVE(LEFT)LG42V6(6871QLH034A)
X56106	PCB ASSY X-DRIVE(LEFT)LG42V6 (6871QRH037A)
X56107	PCB ASSY YSUS LG42V6 (6871QYH029A)
X56108	PCB ASSY XSUS LG42V6 (6871QZH033A)
X56109	PCB ASSY SMPS(PSU) LG42V6 (6709Q00150A)